

www.se.com
W9 1378085 0511 A16
03 - 2023
© 2023 Schneider Electric - All rights reserved.

Schneider Electric Limited
Stafford Park 5
Telford, TF3 3BL
United Kingdom
www.se.com/uk

UK
CA

HAZARD OF ELECTRIC SHOCK, EXPLOSION, OR ARC FLASH
Disconnect all power before servicing equipment. Failure to follow these instructions will result in death or serious injury.

▲▲ DANGER / 危险
电击、爆炸或电弧闪光危险
在此电力设备上进行操作时，请先断开所有电源。不遵守上述规定将可能导致人员伤亡。









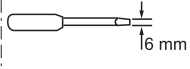

For motor starting use Schneider Electric TeSys Protect - K overload relays. 电动机启动请使用施耐德电气 TeSys/保护 K 系列热过载继电器。





▲ WARNING: This product can expose you to chemicals including Antimony oxide (Antimony trioxide), which is known to the State of California to cause cancer. For more information go to www.P65Warnings.ca.gov.

Phillips head 'PH'  PH2

Pozidriv head 'PZ'  PZ2



									
mm	mm ²	mm ²	mm ²	mm ²	mm ²	mm ²	mm ²	mm	mm
1 x 6,35 2 x 2,8	0,34 · · · 2,5	0,34...2,5 +	0,75...4	0,75...4 +	1,5...4	1,5...4 +	1,5...4	7	7

			
C	L	Ø	L
N.m	mm	mm	mm
1,3	7	3	8

3P AC TeSys K contactors are grade 2 according to GB 21518.
Maximum power consumption lower than 5,0 VA.
根据 GB 21518 标准。
三相 TeSys K 系列交流接触器能效等级为 2 级。
产品最大吸持功率低于 5,0 VA

AWG: 1 x 18 min, 2 x 14 or 1 x 12 max
规格: 1 x 18 最小值, 2 x 14 或 1 x 12 最大值

Torque 0.8-1.3 N.m (7-12 lb-in)
扭矩: 0.8-1.3 N.m (7-12 lb-in)

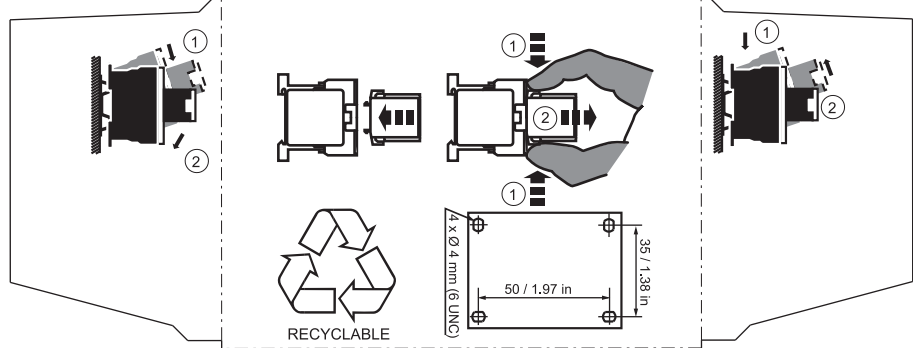

PLEASE NOTE
Electrical equipment should be installed, operated, serviced, and maintained only by qualified personnel. No responsibility is assumed by Schneider Electric for any consequences arising out of the use of this material.

请注意
电气设备的安装、操作、维修和维护工作 仅限于合格人员执行。Schneider Electric 不承担由于使用本资料所引起的 任何后果。

▲▲ WARNING / 警告
HAZARD OF FIRE OR ELECTRIC SHOCK (FOR CONTACTOR WITH UL HI-FAULT SHORT CIRCUIT CURRENT RATINGS ONLY)

- The opening of the branch-circuit protective device may be an indication that a fault current has been interrupted.
- To reduce the risk of fire or electric shock, current-carrying parts and the other components of the controller should be examined and replaced if damaged.

Failure to follow these instructions can result in death, serious injury, or equipment damage.

有火灾或电弧灼伤危险 (仅当继电器发生超故障短路电流时)

- 分支电流保护装置断开可能表明某故障电流已被切断。
- 为减少火灾或电弧灼伤的危险，应经常检查和更换 (如损坏) 控制器的带电部分及 其它部件。

不遵循上述说明可能导致人员伤亡或设备损坏。

